

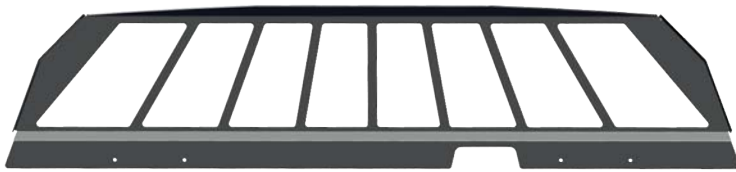

INSTALLATION INSTRUCTIONS
'16-'18 CHEVY SILVERADO SSV
SINGLE CELL LITE
475-1179

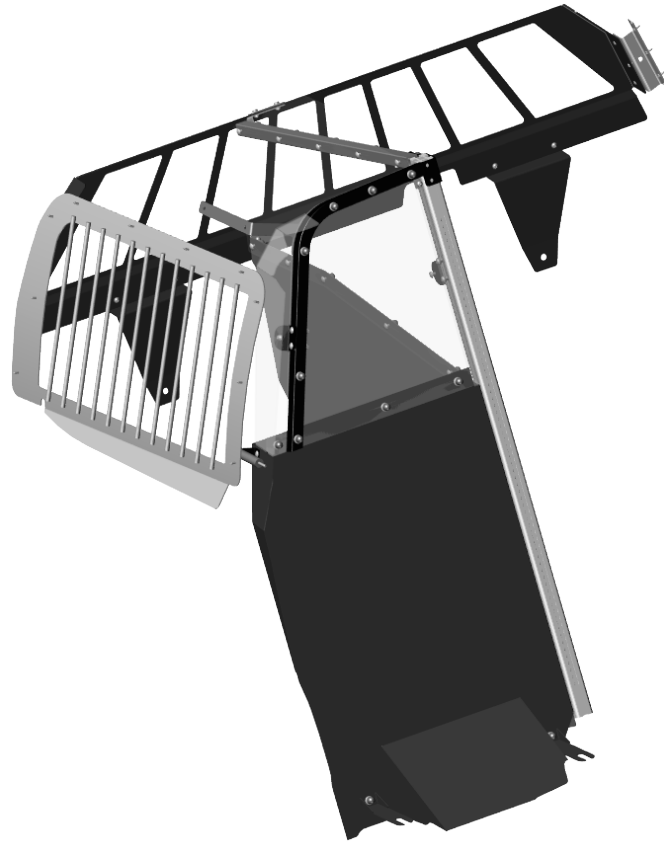

Rear Window Armor



D/S Side Mount Bracket

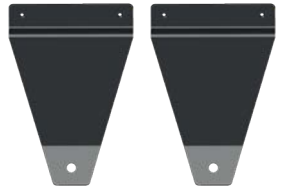

Lower Mount Bracket



P/S Side Mount Bracket



Upper Poly Wing



Assembled Front Divider

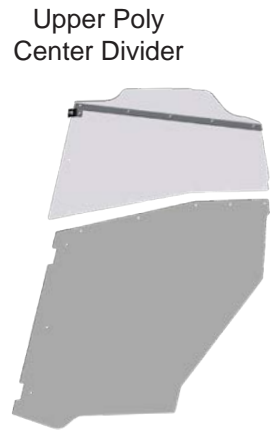

Upper Poly Center Divider

Lower Steel Center Divider



P/S Door Window Armor



Window Armor Brackets



B Pillar Bracket



Inner Foot Mount Brackets



Headliner Handle Bracket



INSTALLATION INSTRUCTIONS '16-'18 CHEVY SILVERADO SINGLE CELL LITE

*Install Rear Window First

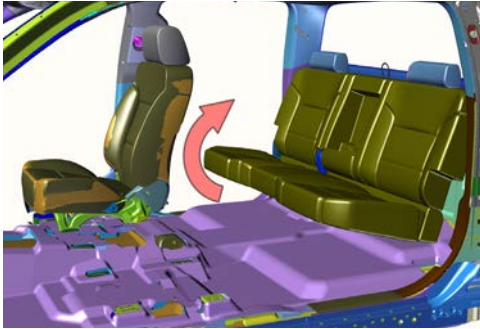

Fold rear seat upwards to remove the (10) 18mm nuts from the underside of seat. Images are for reference only.

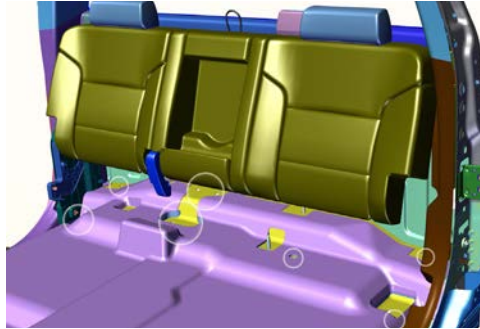

Lift rear seat upward to allow it to unhook from the rear latch. Set seat aside.

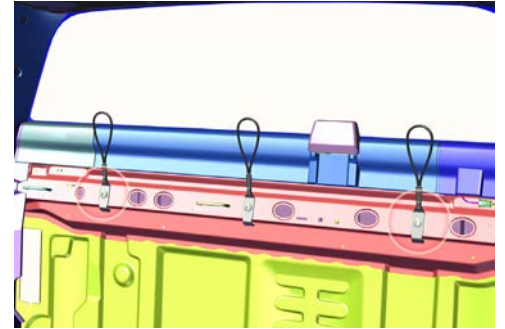

Remove (2) T50 OEM bolts from child restraint loops.

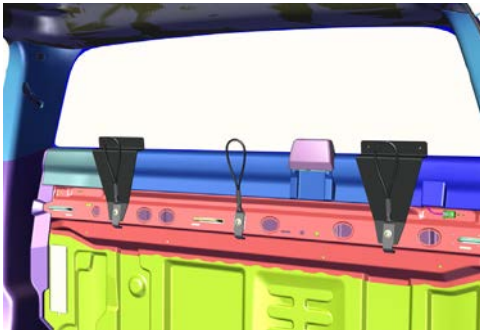

Loosely attach Lower Brackets into place using the previously removed (2) T50 OEM bolts and restraint loops.

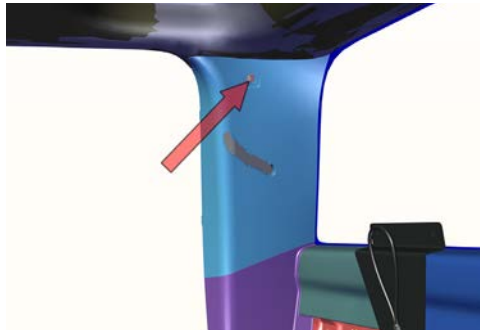

Remove "C" pillar upper OEM trim by first removing 7mm bolt from behind plastic clip. Then carefully pull trim away from frame. When you have the trim pulled slightly away, there are two plastic clips to separate the upper and lower "C" pillar trim.

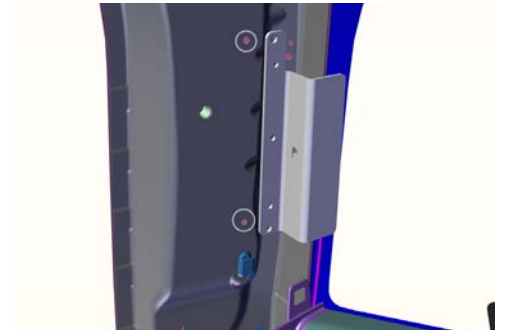

Using the upper and lower hole pattern on Side Mount Brackets (shown with circles) align to OEM holes for proper position. When in place, secure to frame using provided (3) tek screws.



Replace OEM "C" pillar trim.

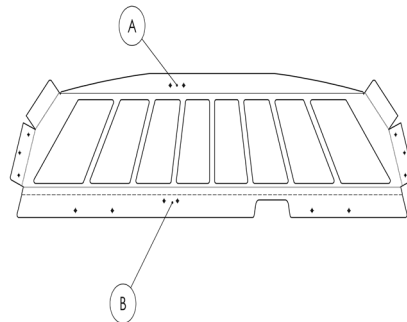

Use provided template to locate and drill out hole location for Window Armor Center Brackets.



Loosely attach Window Armor Brackets to Rear Window Armor.



INSTALLATION INSTRUCTIONS '16-'18 CHEVY SILVERADO SINGLE CELL LITE

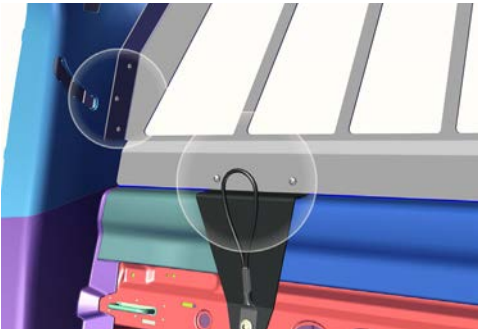

Before attaching rear window armor, place provided foam pads onto each upper corner of window armor closest to glass. Install Rear Window Armor into vehicle using provided (4) button head cap screws on lower brackets and (6) tek screws on side brackets.

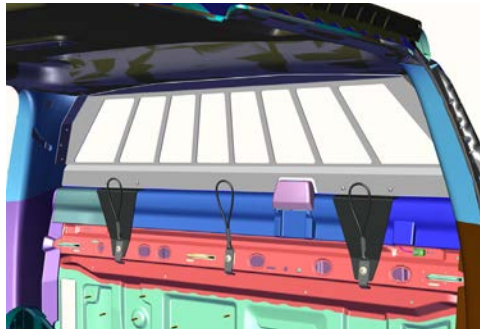

Once Window is in position, tighten all hardware.

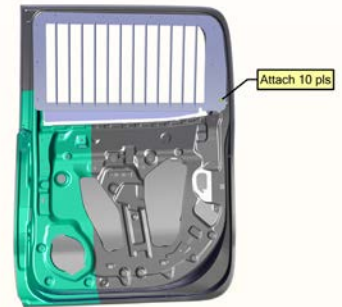

Align Door Window Armor into position following contour of door frame. Secure Window Armor into place using provided tek screws.



Slide P/S front seat completely forward. Loosen the rear OEM T45 seat bolts.



Push seat up slightly to slide the Foot Mount Brackets under seat rails, between rail and carpet. Leave bolts loose at this time.

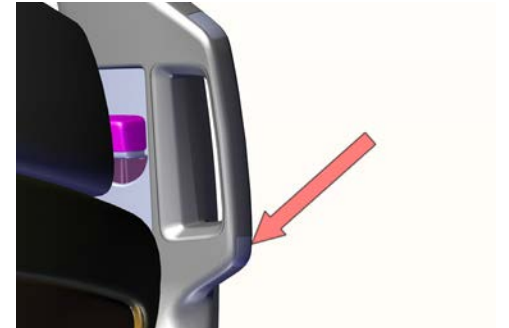

Remove cover from lower sections of handle located on B pillar, and then remove 10mm bolt.

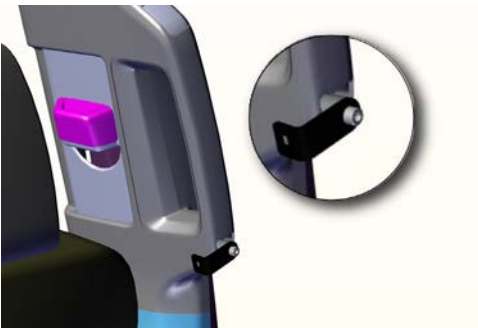

Loosely attach Spacer and B Pillar Bracket into OEM lower handle location.



***** OPTIONAL ***** You may separate rear OEM seats held together by (2) 10mm OEM bolts. This will allow easier installation.

Reinstall OEM D/S rear seats now.

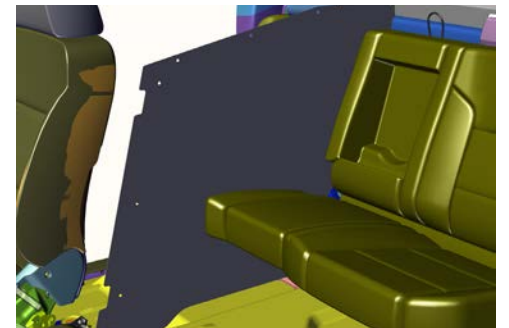

Insert Lower Steel Center Divider into vehicle between seats.

***All Carriage Bolts Attach From Prisoner Side.
Nuts and Nut Covers on D/S.**



INSTALLATION INSTRUCTIONS '16-'18 CHEVY SILVERADO SINGLE CELL LITE



Install Assembled Front Divider into vehicle. This will require a little twisting to get into proper position.

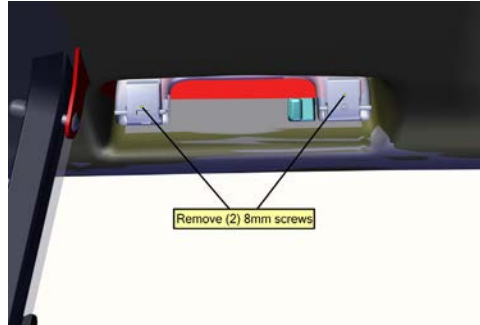

Remove covers from P/S grab handle exposing (2) 8mm bolts. Remove bolts and set grab handle aside.



Loosely attach Headliner Handle Bracket into grab handle location. Reuse OEM bolts.

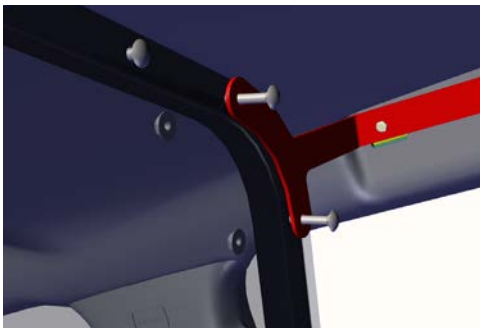

Loosely attach Headliner Handle Bracket onto Assembled Front Divider. Use provided carriage bolt and flange nut.

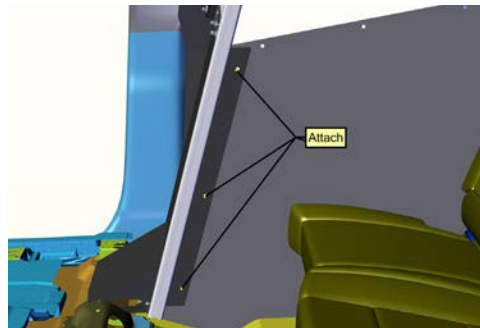

Loosely secure Lower Steel Center Divider onto Assembled Front Divider using provided carriage bolts and flange nuts.

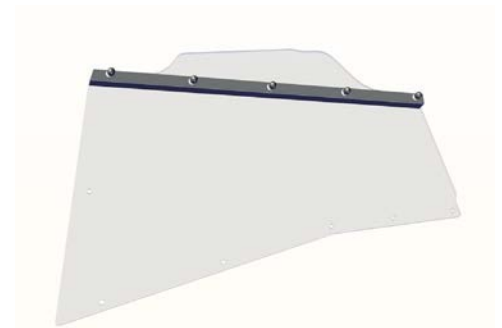

Attach Stiffener Tube to D/S of Upper Poly Center Divider.

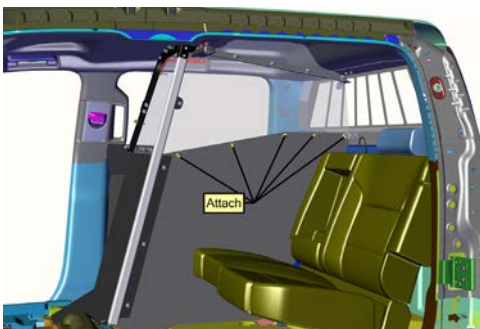

Attach Upper Poly Center Divider to Lower Steel Center Divider and Assembled Front Divider using provided carriage bolts and flange nuts. Tighten all bolts at this time.

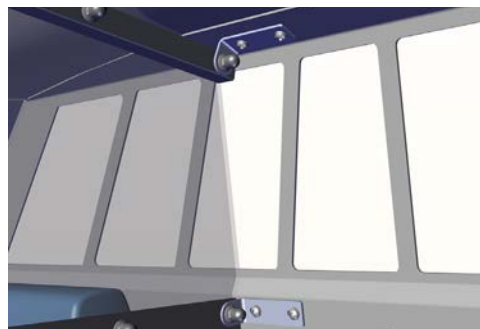

Secure Upper and Lower Center Divider to Rear Window Armor using Window Armor Center Brackets and carriage bolts and flange nuts.

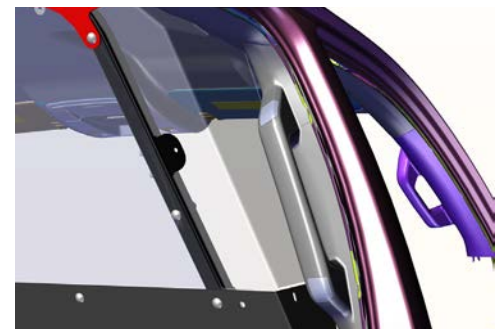

Install Upper Poly Wing from front of vehicle using carriage bolts and flange nuts.

***All Carriage Bolts Attach From Prisoner Side.
Nuts and Nut Covers on D/S.**



209 W. EASY ST., ROGERS, AR 72756 • www.EVERYTHINGBUTLIGHTS.com • 01/19

Jotto Desk® is a patented product and Registered Trademark of Assembled Products™ Corporation.
Specifications subject to change without notice.

Passenger Side

Driver Side



Bottom Template
Print PDF in format "ACTUAL SIZE"

Passenger Side

Driver Side



Top Template
Print PDF in format "ACTUAL SIZE"