



UDRH VEHICLE PARTITION

FEATURING UNIDIRECTIONAL RECESSED HOUSING

2020+ DODGE DURANGO

Installation Instructions

Space Creator with High Security/High Visibility Window - 475-1556

Space Creator with Full Window w/ Safety Wire Window - 475-1555

Transfer Kit - 475-1545



475-1556

Durango UDRH Partition with HS/HV Window



475-1555

UDRH Partition with Full Window & Safety Wire

Before beginning the installation, confirm that you have received all of the parts for your package.

Read the instructions completely before starting installation.

Always install Cargo Barrier before Partition if ordered.



DS-

- PS

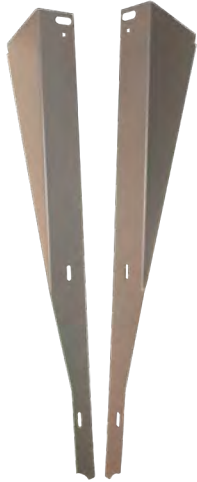

Wings Set



Center HSEP

DS-

- PS



(2) B Pillar Bracket

DS-

- PS



(2) Mounting Foot



Unidirectional
Recessed Housing



ABS Headliner
Blank

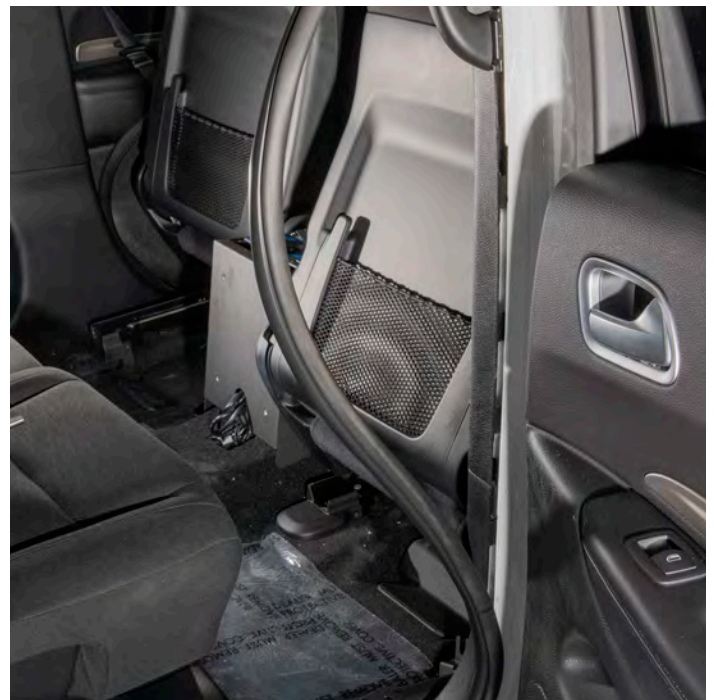

1. Pull back rubber seal away from B-pillar to remove trim.



2. Pop plastic clips and remove lower B-Pillar trim.



3. Using 3/2 socket remove exposed screw from upper B-Pillar trim. Remove upper B-Pillar trim.



4. Use a 10 mm socket to remove both OEM bolts and grab handles.
NOTE: PART NOT REINSTALLED

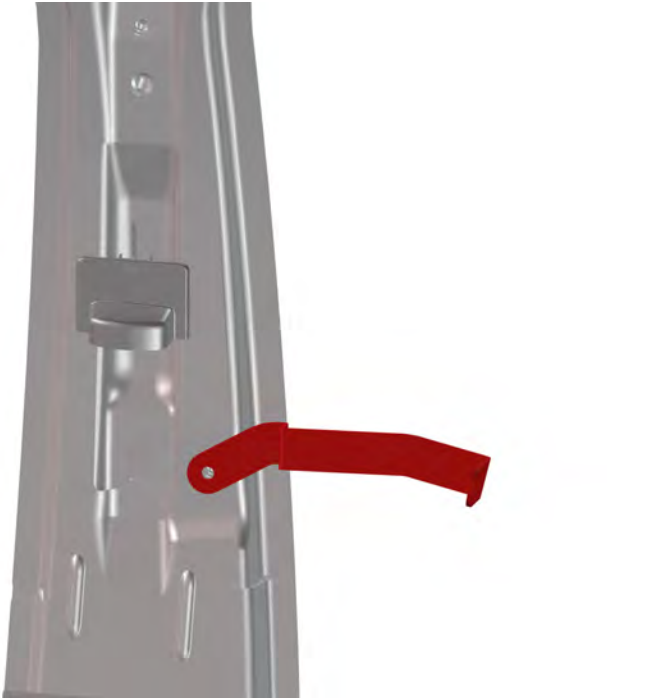

5. Use (1) 10mm OEM bolt previously removed to attach B-Pillar Bracket to the lower hole of grab handle.



6. Move seat completely forward. Use a small flat head screwdriver to pry off cover exposing seat bolt. Remove the rear/outer OEM 15 mm seat bolts.



7. Place Mounting Foot Bracket on top of seat rail. Replace and tighten DS/PS OEM bolt and covers at this time.



8. Remove and disconnect rear controls from headliner if vehicle has them.



9. Detach the Rear AC Control Box from component housing. Then reconnect to harness and position back into place.



10. Install ABS Headliner blank using the provided (4) black pan head screws.

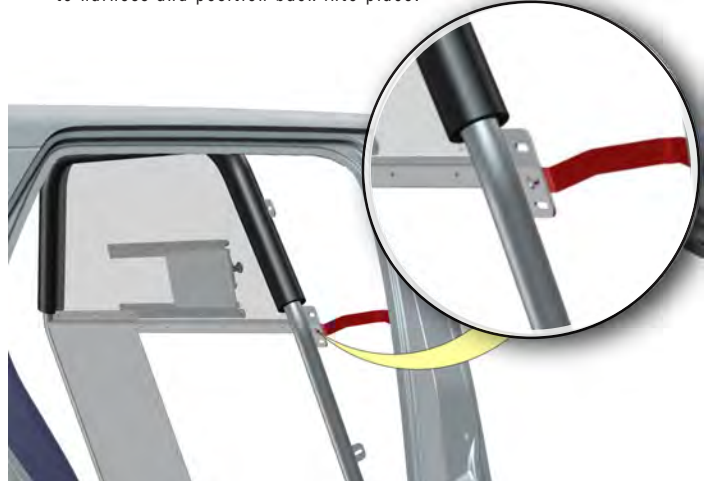

11. Reinstall B-Pillar trim as it was previously removed with rubber seals.
12. Place the frame of the Partition onto the Mounting Feet.
13. To avoid interference with headliner, remove blue protective film covering window at this time.
14. Push the Partition frame forward to the B-Pillar Brackets and secure using the middle slots of the mounting tabs.

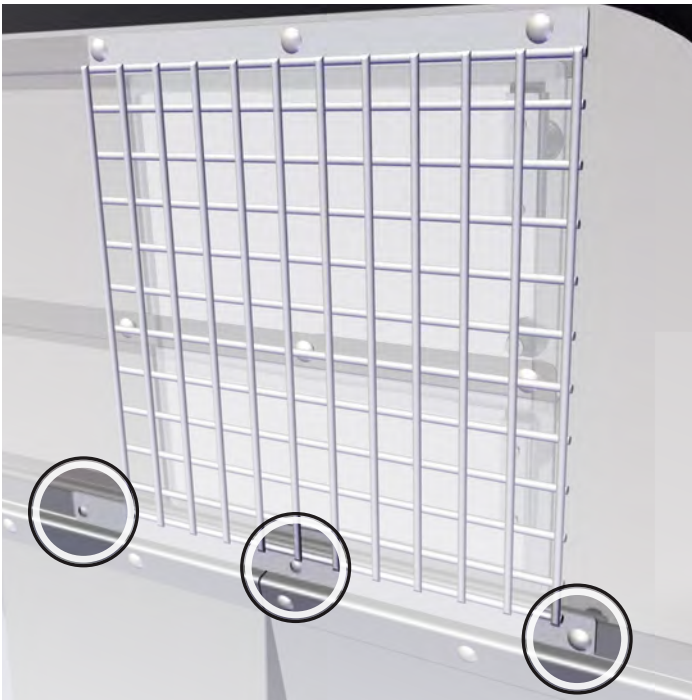

- 15. Before you install the UDRH you will need to remove the lower window channel and sliding window by removing the hand tightened carriage bolts and nuts.
- 16. Remove and set aside for reuse.



- 17. When installing the UDRH, be certain the UDRH Safety-Wire is installed on the outside of the UDRH.
- 18. It will be necessary to pull the bottom of the safety-wire out so the UDRH can slip underneath.

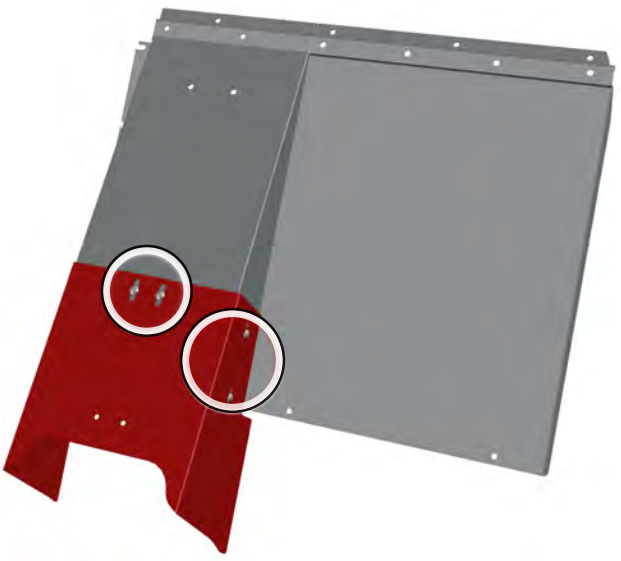

- 19. Outside of vehicle, loosely attach the center HSEP to the UDRH. With assistance, place the UDRH into the rear of the vehicle and secure the partition frame using the provided hardware.



- 20. Once the UDRH has been attached to the partition frame, replace lower window channel and sliding window.
- 21. Secure with provided hardware.

Driver's Side of Partition

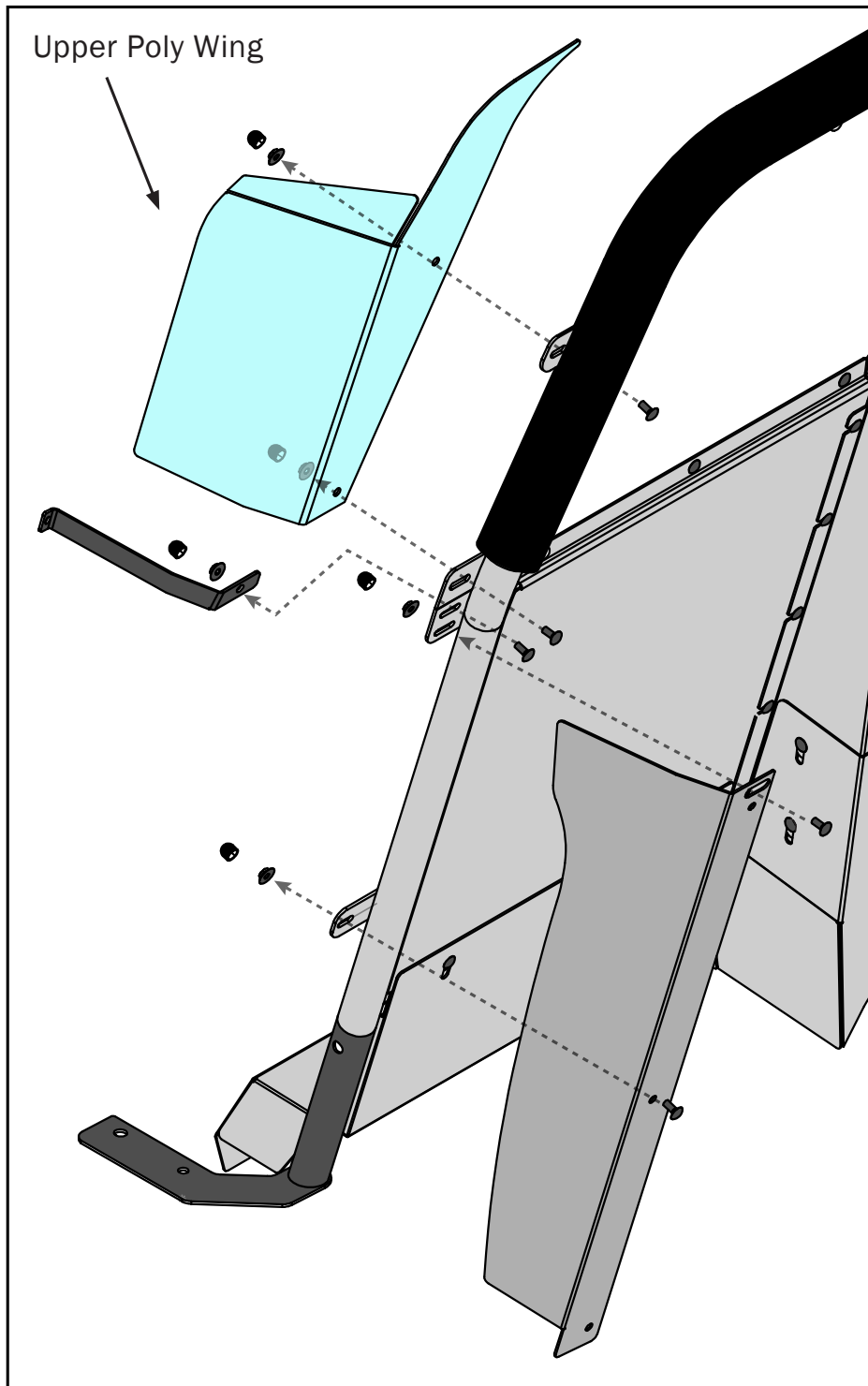

Poly Wing Installation Instructions

1. Install the optional D/S and P/S HSEP to the partition and UDRH, using provided hardware.
2. Attach Lower Steel Side Wings to BACK/ Prisoner side of the mounting tabs on the partition frame using provided hardware. Use the bottom hole of the middle tab.
3. Attach Upper Poly Wings to the FRONT/ OFFICER side of the mounting tabs. Use the top hole of the middle tab with a carriage bolt. The top of the Poly Wing should be secured with a carriage bolt as well. All flange nuts get plastic nut covers.

If you have questions or need further assistance please call Technical Support: 1.877.455.6886



209 W. EASY ST., ROGERS, AR 72756 • JOTTOPUBLICSAFETY.COM • 9/24

Jotto Desk™ is a patented product and Registered Trademark of Assembled Products™ Corporation.
Specifications subject to change without notice.

050-0072-00

