



# UDRH VEHICLE PARTITION

FEATURING UNIDIRECTIONAL RECESSED HOUSING

## 2021+ CHEVY TAHOE

### Installation Instructions

Space Creator with High Security/High Visibility Window - 475-1677

Space Creator with Full Window w/ Safety Wire Window - 475-1678

Transfer Kit - 475-1680

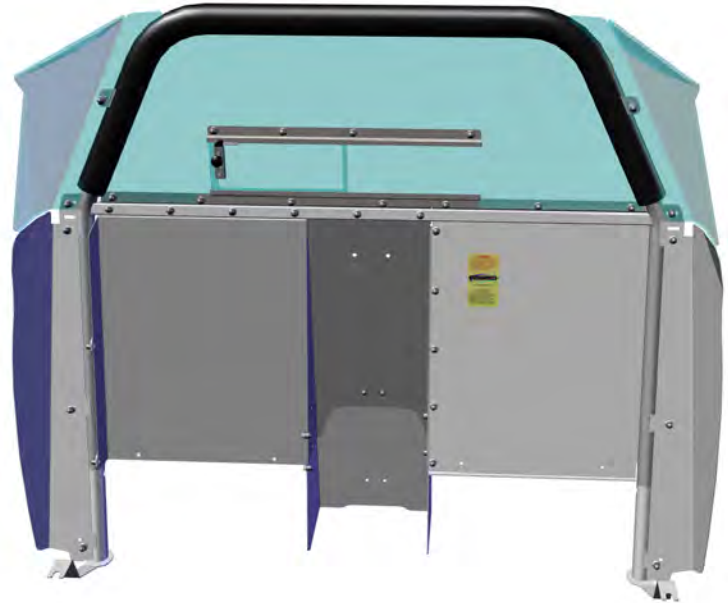

### 475-1677

Vehicle Partition with HS/HV Window  
Featuring Unidirectional Recessed Housing



### 475-1678

Vehicle Partition with Full Window & Safety Wire  
Featuring Unidirectional Recessed Housing

Before beginning the installation, confirm that you have received all of the parts for your package.

Read the instructions completely before starting installation.

**Always install Cargo Barrier before Partition if ordered.**

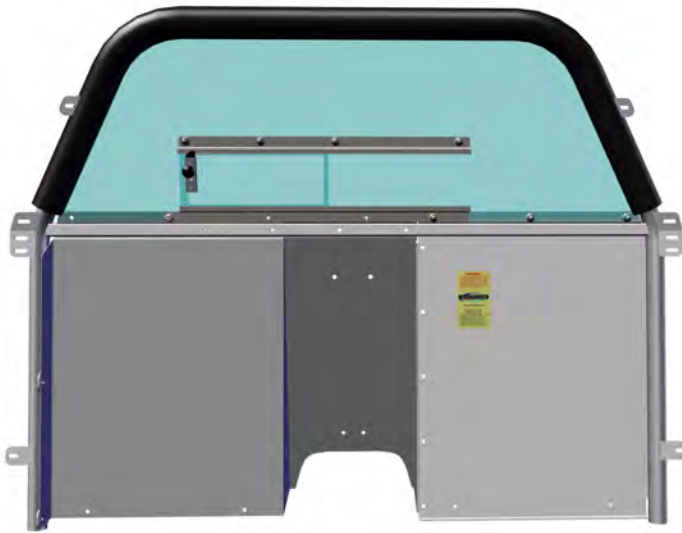

Partition (475-1677)



Partition (475-1678)

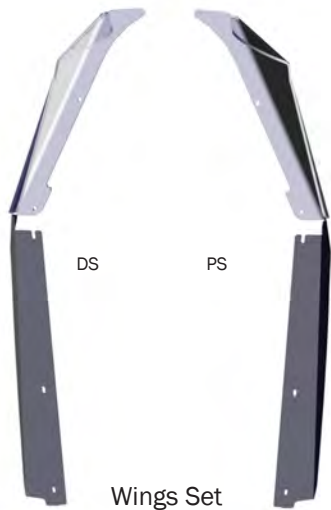

Wings Set

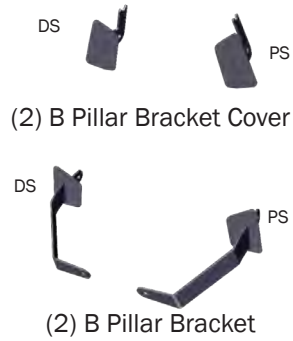

Center HSEP



(2) Mounting Foot

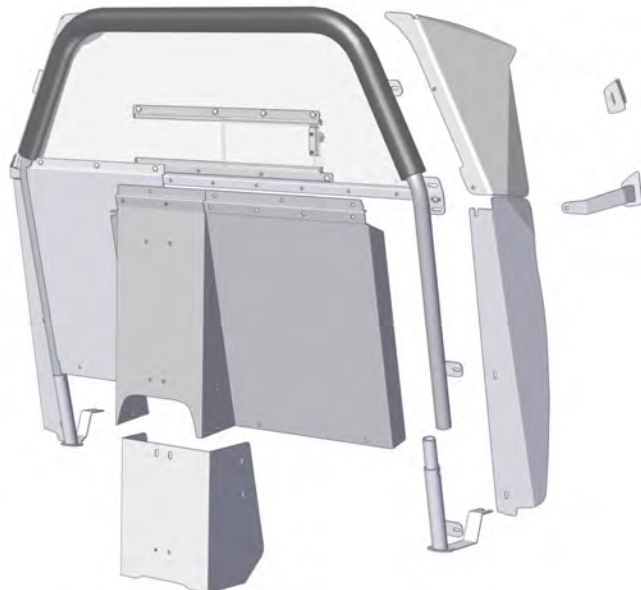

UDRH: Unidirectional Recessed Housing



HSEP: High Security Extension Panel  
*optional*

## Install Cargo Barrier (CB4) BEFORE Installing Partition



1. Move seats completely forward and loosen the rear outside (T-50 Bolts).



2. Push the seat up slightly to slide the Mounting Foot under seat rail, between rail and vinyl / carpet. Leave bolt loose on this step. Repeat on other side.

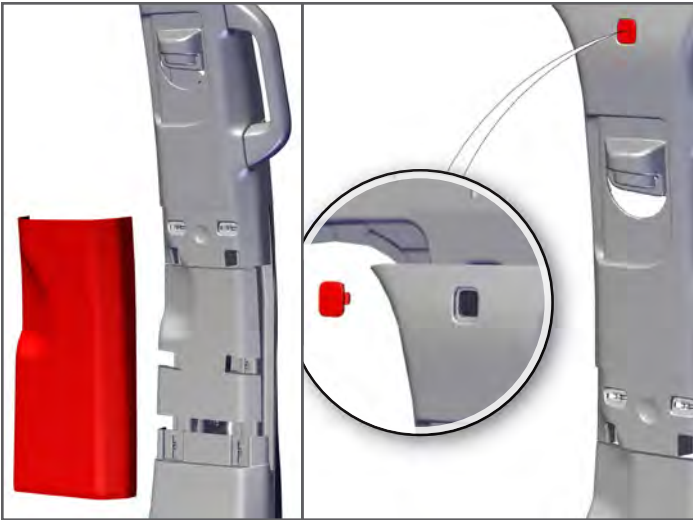

3. With slight pressure, pull to unclip the center "B Pillar trim" from its location. Once removed, remove the upper B-Pillar trim by popping out square trim cover, giving access to the 9/32" screw at the top of the headliner.

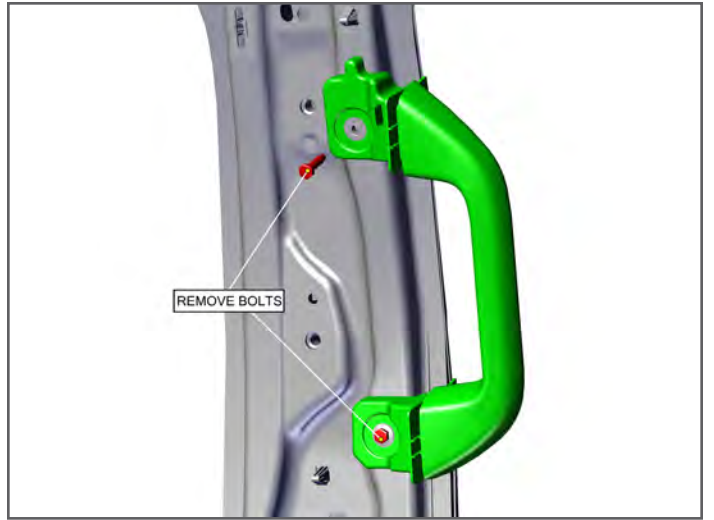

4. Utilize a 10mm socket to remove the DS/PS Grab Handle.  
**Grab Handle Not Reused**

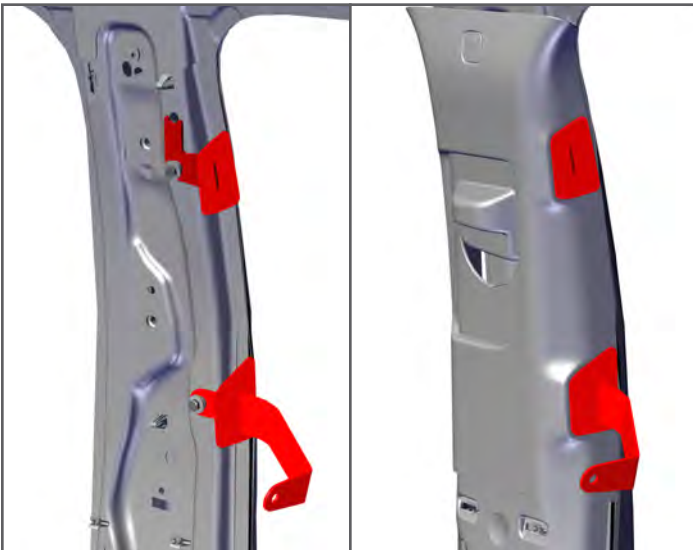

5. Attach the DS/PS B-Pillar Cover Brackets and B-Pillar Brackets with previously removed 10 mm bolts. Replace upper B-Pillar trim and secure with previously removed 9/32" screw. Finish by snapping back into place the center B-Pillar trim.



6. Install Partition frame into vehicle through DS door and position onto mounting feet.



7. Lean Partition frame forward and loosely attach DS/PS B-Pillar Brackets to middle hole of frame. Center the partition. Once centered, tighten all hardware.

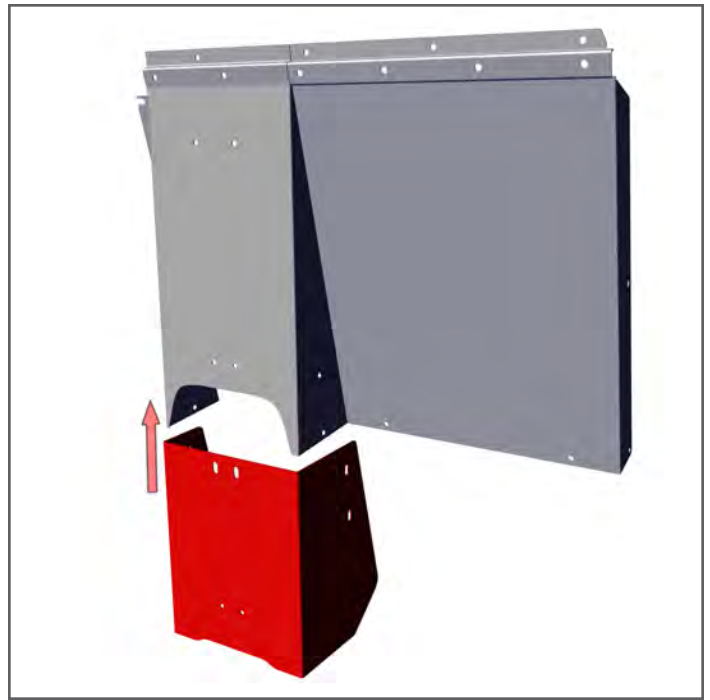

8. Loosely attach Center HSEP onto UDRH outside of vehicle with provided carriage bolts and flange nuts.

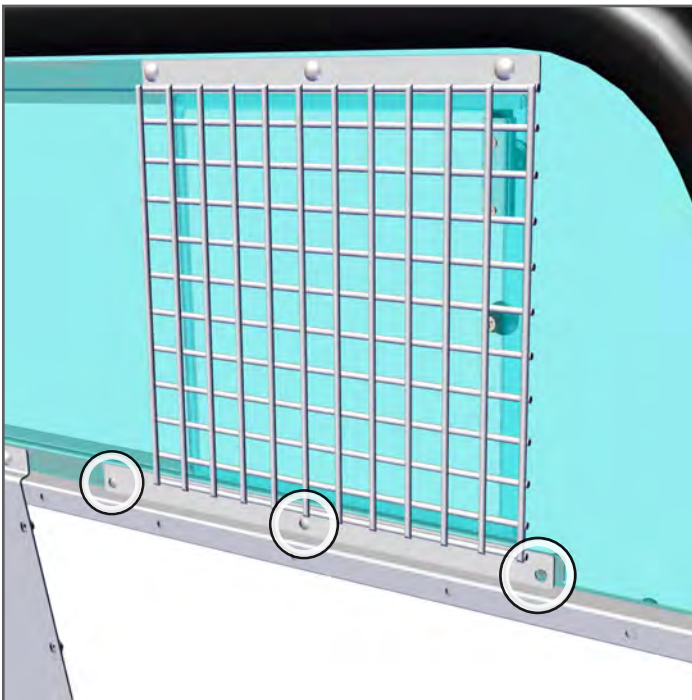

**STEP 9-11 (FOR FULL WINDOW ASSEMBLY ONLY)**

9. Before you install the UDRH you will need to remove the lower window channel and sliding window by removing the hand tightened carriage bolts and nuts. Remove and set aside for reuse.

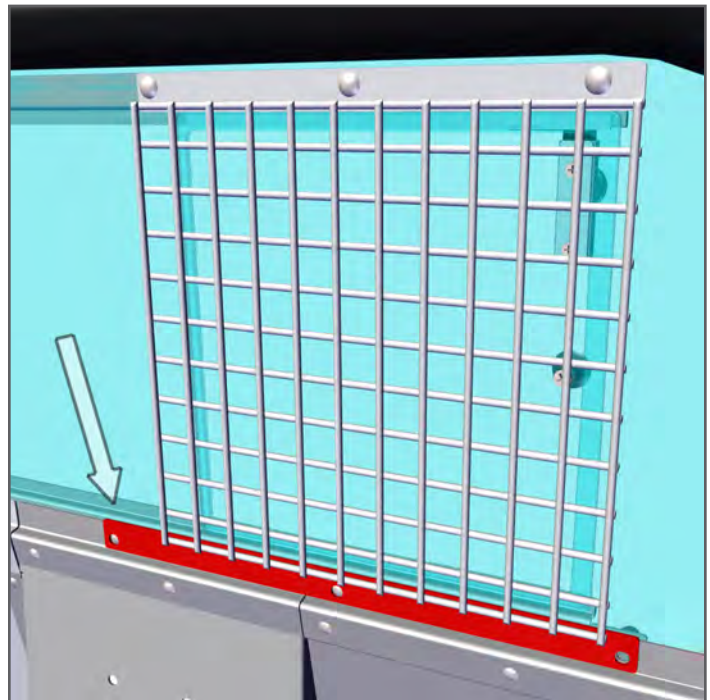

10. When installing the UDRH, be certain the Safety-Wire is installed on the outside of the housing. It will be necessary to pull the bottom of the Safety-Wire out so the UDRH can slip underneath..

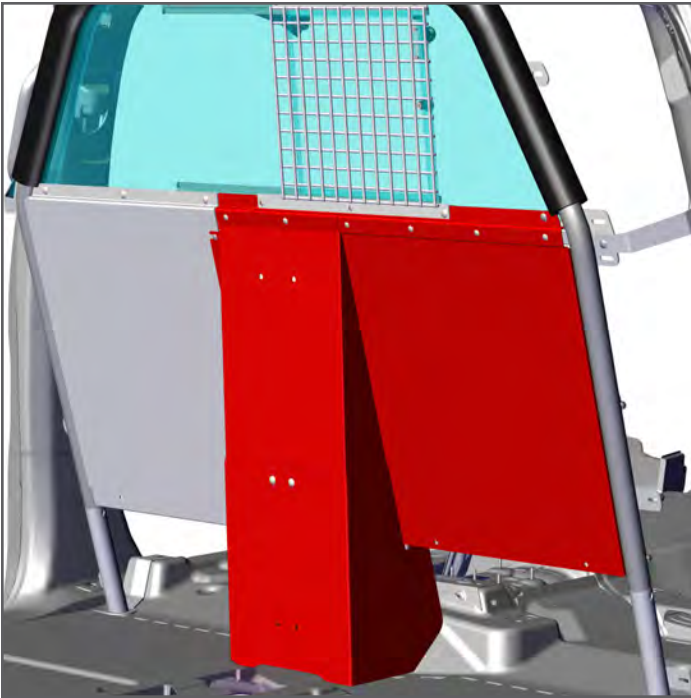

11. Install the assembled UDRH with HSEP to the Partition Frame with previously removed and supplied carriage bolts and flange nuts. Tighten all bolts/nuts. **SOLO INSTALL NOTE:** Use making tape over carriage bolts to hold in place while attaching flange nuts from front side of partition.

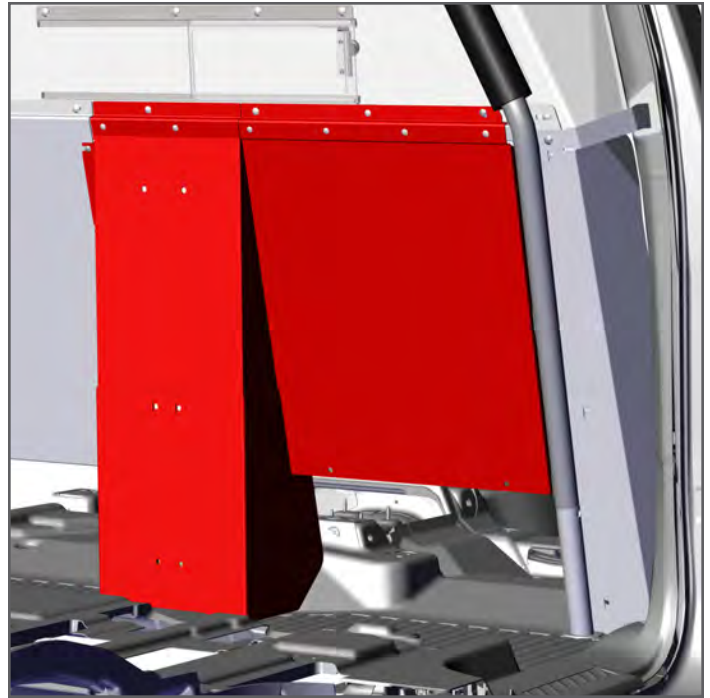

**STEP 12 (FOR HS/HV WINDOW ASSEMBLY ONLY)**

12. Place assembled UDRH with Center HSEP into vehicle. Attach the housing To Partition Frame using provided carriage bolts and flange nuts. Push Carriage bolts in from prisoner side of partition. Tighten all bolts/nuts.

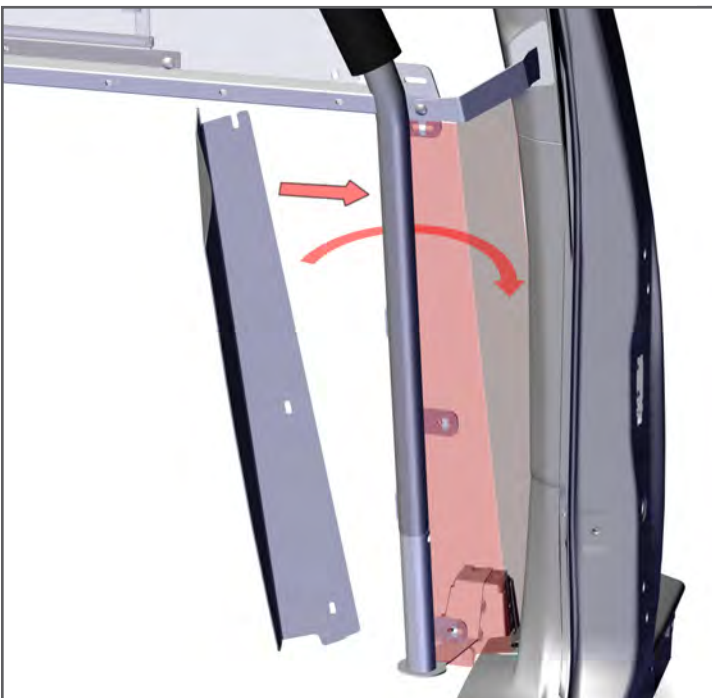

13. Attach the DS/PS Lower Steel Wings through the front of the Partition backwards rotating them 90 degrees around the front side of the tube and mounting tabs of the Partition. Secure with provided carriage bolts and flange nuts.

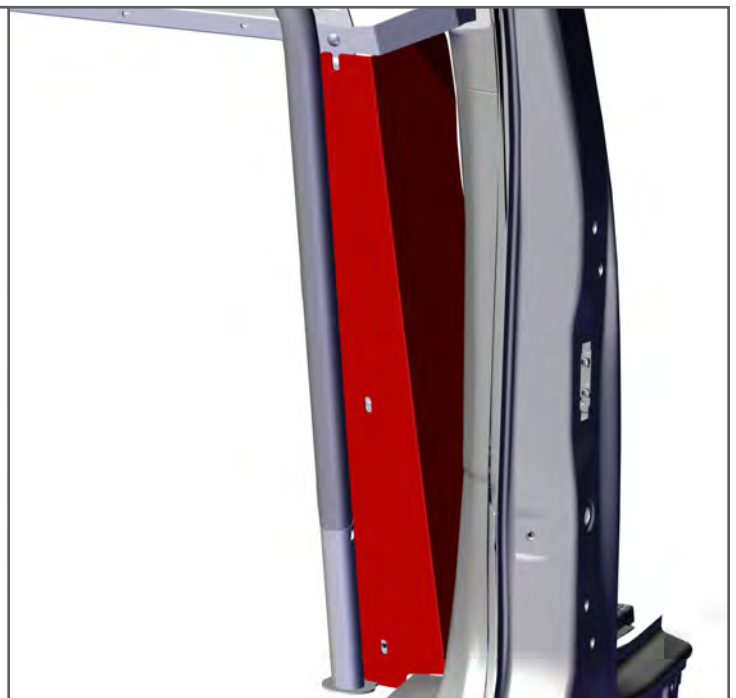



14. Install Upper Poly Wing from officer side and secure with provided carriage bolts and flange nuts. Install cap nut covers on all flange nuts.



If you have questions or need further assistance please call Technical Support: 1.877.455.6886



**209 W. EASY ST., ROGERS, AR 72756 • JOTTOPUBLICSAFETY.COM • 9/24**

Jotto Desk™ is a patented product and Registered Trademark of Assembled Products™ Corporation.  
Specifications subject to change without notice.

050-0081-00

